

KENWOOD

STEREO RECEIVER

KR-896 KR-796 KR-596

INSTRUCTION MANUAL

KENWOOD CORPORATION

For your records

Record the serial number, found on the back of the unit, in the spaces designated on the warranty card, and in the space provided below. Refer to the model and serial numbers whenever you call upon your dealer for information or service on this product.

Model _____ Serial Number _____

Unpacking

Unpack the unit carefully and make sure that all accessories are put aside so they will not be lost.

Examine the unit for any possibility of shipping damage. If your unit is damaged or fails to operate, notify your dealer immediately. If your unit was shipped to you directly, notify the shipping company without delay. Only the consignee (the person or company receiving the unit) can file a claim against the carrier for shipping damage.

We recommend that you retain the original carton and packing materials for use should you transport or ship the unit in the future.

Accessories

Remote control unit 1 Batteries (R6/AA) 2 FM indoor antenna 1



Loop antenna stand 1



AM loop antenna 1
(The shape of the loop antenna provided may differ depending on the area.)



Contents

Read the pages marked carefully to ensure safe operations.

Before applying power 2	Operation of Dolby Surround playback (KR-896/KR-796 only) 14
Safety precautions 2	Operation of Dolby PRO LOGIC playback (KR-896/KR-796 only) 15
System connections 3	Dolby 3 STEREO Mode (KR-896/KR-796 only) 17
FM DE-EMPHASIS/CHANNEL SPACE switch 5	In case of difficulty 18
Controls and indicators 6	Specifications 19
Remote control operation 8	
Operating instructions 10	
Reception of radio broadcast 12	

Special features



Caution: Read this page carefully to ensure safe operation.

- DOLBY SURROUND PRO LOGIC** : This function allows to enjoy a similar Dolby Surround effect to movie theaters from video software programs carrying the mark.
- DOLBY 3 STEREO** : The Dolby 3 STEREO provides an active center channel to produce a better, stable center image. This mode can be used when listening to stereo video program and music or when surround listening or surround system set-up is not possible.
- Remote control unit** : The remote control unit is provided with this unit.
- ADAPTOR jacks** : These jacks can be connected to the other equipment such as second tape deck or graphic equalizer.
- Preset frequency recall** : Preset reception frequency recall can be possible by simply pressing the P.CALL key.

Before applying power

Units are designed for operations as follows.

U.S.A. and Canada **AC 120 V only**

***Other countries** **AC110-120/220V/230-240 V switchable**

*AC voltage selection

The AC voltage selector switch on the rear panel is set to the voltage that prevails in the area to which the unit is shipped. Before connecting the power cord to your AC outlet, make sure that the setting position of this switch matches your line voltage. If not, it must be set to your voltage in accordance with the following direction.

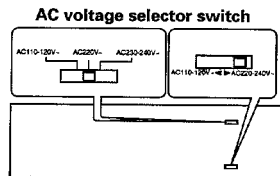

Move switch lever to match your line voltage with a small screwdriver or other pointed tool.

Note:

Our warranty does not cover damage caused by excessive line voltage due to improper setting of the AC voltage selector switch.

Safety precautions

WARNING: TO PREVENT FIRE OR ELECTRIC SHOCK, DO NOT EXPOSE THIS APPLIANCE TO RAIN OR MOISTURE.

	CAUTION RISK OF ELECTRIC SHOCK DO NOT OPEN		CAUTION: TO REDUCE THE RISK OF ELECTRIC SHOCK, DO NOT REMOVE COVER (OR BACK). NO USER-SERVICEABLE PARTS INSIDE, REFER SERVICING TO QUALIFIED SERVICE PERSONNEL.
	THE LIGHTNING FLASH WITH ARROWHEAD SYMBOL, WITHIN AN EQUILATERAL TRIANGLE, IS INTENDED TO ALERT THE USER TO THE PRESENCE OF UNINSULATED "DANGEROUS VOLTAGE" WITHIN THE PRODUCT'S ENCLOSURE THAT MAY BE OF SUFFICIENT MAGNITUDE TO CONSTITUTE A RISK OF ELECTRIC SHOCK TO PERSONS.		
	THE EXCLAMATION POINT WITHIN AN EQUILATERAL TRIANGLE IS INTENDED TO ALERT THE USER TO THE PRESENCE OF IMPORTANT OPERATING AND MAINTENANCE (SERVICING) INSTRUCTIONS IN THE LITERATURE ACCOMPANYING THE APPLIANCE.		

System connections

Make connections as shown below. When connecting the related system components, refer also to the instruction manuals of the related components. Do not plug in the power lead until all connections are completed.

Regarding malfunctions of the microprocessor, see "In case of difficulty" to reset the microprocessor if the display indications are distorted or the unit won't operate even though you completed the connections correctly.

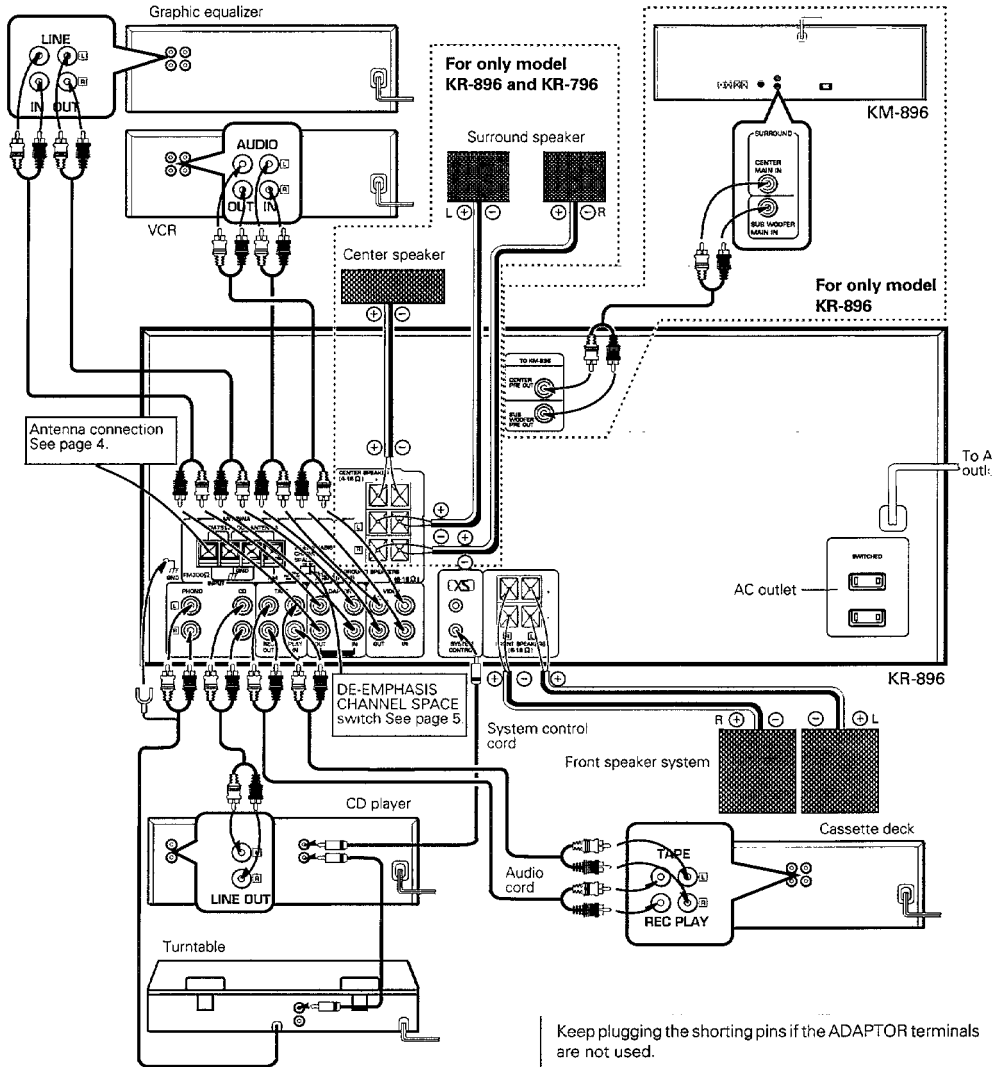

Notes:

1. Connect cords firmly. If connections are loose, there could be loss sound or noise produce.
2. When plugging and unplugging connection cords, be sure to first remove the power cord from the AC outlet. Plugging/unplugging connection cords without removal of the power cord can cause malfunctions or damage to the unit.
3. Do not connect up a power source which is larger than that indicated on the socket at the rear of the unit.

System connections

Connection method to each antenna terminal

- ① Push the lever.
- ② Insert the cord.
- ③ Return the lever.

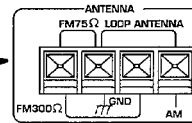
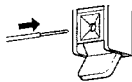

■ AM loop antenna connection

The supplied antenna is for indoor use. Place it as far as possible from the main system, TV set, speaker cords and power cord, and set it to a direction which provides the best reception.

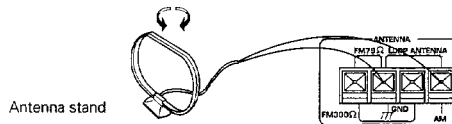

■ AM outdoor antenna connection

If the reception is poor when the AM loop antenna is used, distribute a vinyl-coated wire of more than 6 meters outdoors, without disconnecting the loop antenna.

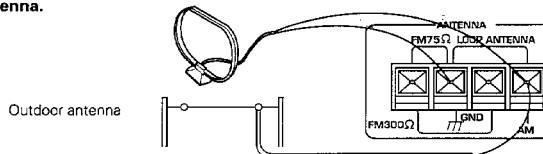

■ FM indoor antenna connection

The supplied antenna is for indoor use. For stable reception, remove the indoor antenna after installing an outdoor antenna as soon as possible.

- ① Remove insulation from wire tip and twist wire tightly.
- ② Find the position that provides best reception.
- ③ Fix the end.

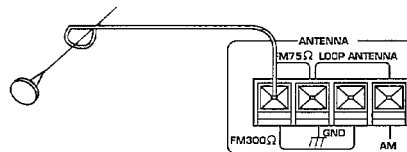

■ FM outdoor antenna connection

It is recommended to install an exclusive FM outdoor antenna to capture FM broadcast with high sound quality. Use a coaxial cable for the connection between the outdoor antenna and FM ANTENNA terminal on the rear panel. For the connection between the coaxial cable and FM ANTENNA terminal, please refer to the illustration.

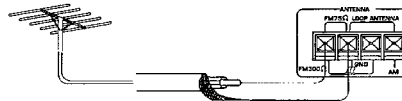

Speakers connection

- ① Push the lever. ② Insert the cord. ③ Lock the lever.

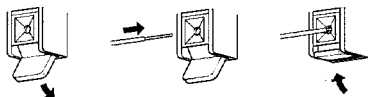

System control connection

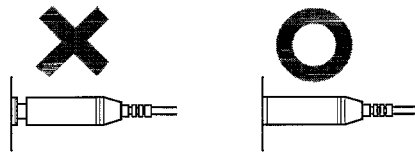

- Be sure to insert the system control cord plugs fully into the SYSTEM CONTROL terminals.
- If the system control cord and audio cords are not connected properly, the automatic system governing remote control and system functions will not operate.

SYSTEM CONTROL Operation (This operation is not available for some cassette decks.)

By connecting this unit to other KENWOOD system components equipped with SYSTEM CONTROL terminals, such as a CD player and/or turntable, the following operations will be available.

Automatic play operation

To play the turntable, or CD player connected to this unit, turn the input selector knob on this unit to the desired position. The turntable, or CD player will automatically enter play mode. In the same way, pressing the Play key of the turntable, or CD player will automatically switch the input selector on this unit to the corresponding component.

Remote control

When the CD player is connected via the system control cords, this component can be controlled from the remote control unit supplied with this unit.

ADAPTOR jacks

When an adaptor-type component such as a graphic equalizer is connected, unplug the shorting pins from the ADAPTOR jacks and connect the component to these jacks.

- When the ADAPTOR jacks are not used, be sure to plug the shorting pins into the jacks. Otherwise, the sound will not be produced.
- When the ADAPTOR jacks are used, retain the shorting pins and be careful not to lose them.
- Never plug a shorting pin into other jacks than ADAPTOR jacks. Otherwise, the unit may be damaged.

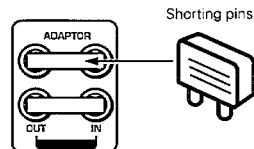

FM DE-EMPHASIS/CHANNEL SPACE switch (Except for the U.S.A., Canada and Australia.)

The FM DE-EMPHASIS/CHANNEL SPACE switch on the rear panel is already set to the correct setting that prevails in the area to which the unit is shipped. However, the FM DE-EMPHASIS/ CHANNEL SPACE setting may be different in some areas. In this case, change the FM DE-EMPHASIS/ CHANNEL SPACE setting as shown in the table.

- When changing the setting of the FM DE-EMPHASIS/ CHANNEL SPACE switch, first disconnect the power cord, then change the switch setting, connect the power cord again, and turn the power on.

Area	CHANNEL SPACE freq.	FM DE-EMPHASIS
1 U.S.A., Canada, and South American countries	FM: 100 kHz AM: 10 kHz	75µs
2 Other countries	FM: 50 kHz AM: 9 kHz	50µs

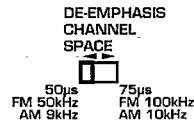

Controls and indicators (KR-896/KR-796)

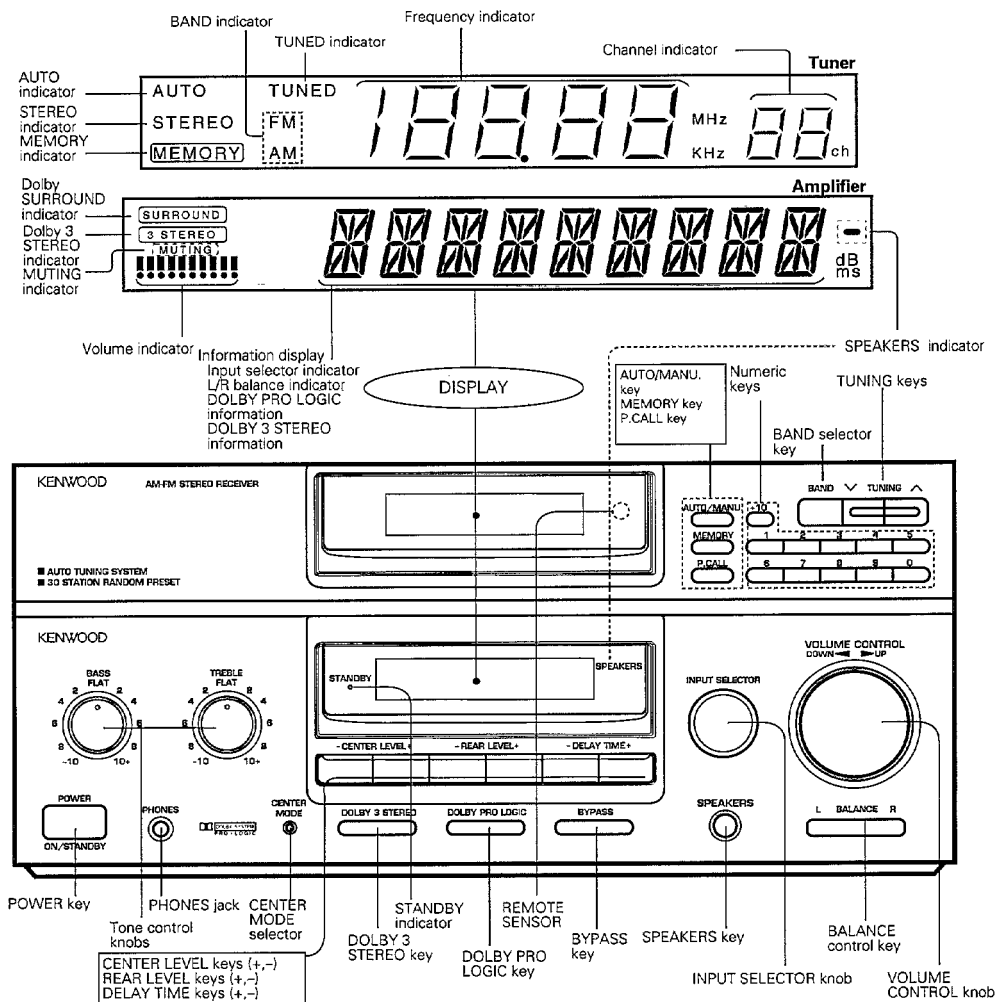

SPEAKERS key
OFF: This position silences all speakers to permit private use of headphones. (Speakers indicator goes off.)
ON: Activates the speakers connected to SPEAKERS terminals on the rear panel. (Speakers indicator lights.)

STANDBY mode of POWER key
 When the power cord of this system is plugged into an AC outlet, the STANDBY indicator lights up regardless of the ON/OFF setting of the POWER switch. This indicates that a small amount of current is being supplied to the unit to back up the memory contents. This mode is referred to as the Standby mode. While the STANDBY indicator is lit, the power of the system can be switched ON/OFF from the remote control unit.

Controls and indicators (KR-596)

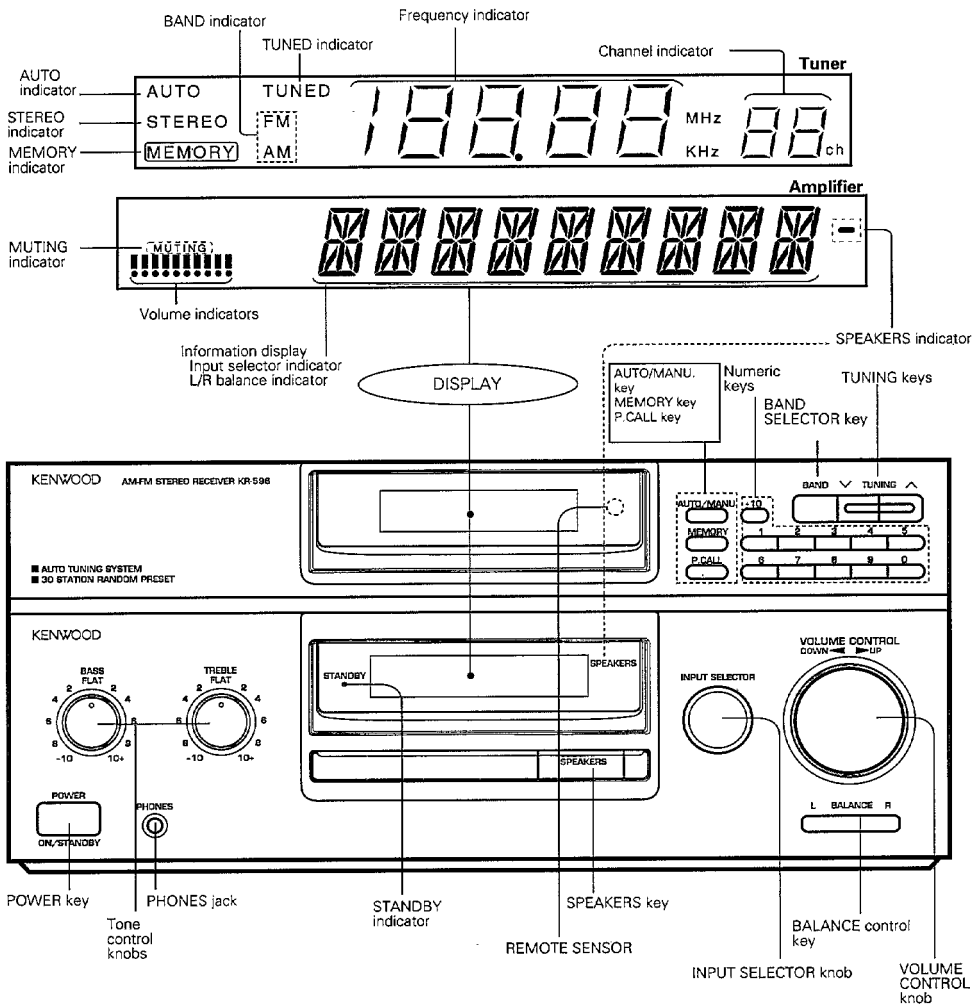

SPEAKERS key

OFF: This position silences all speakers to permit private use of headphones. (Speakers indicator goes off.)

ON: Activates the speakers connected to SPEAKER terminals on the rear panel. (Speakers indicator lights.)

STANDBY mode of POWER key

When the power cord of this system is plugged into an AC outlet, the STANDBY indicator lights up regardless of the ON/OFF setting of the POWER switch. This indicates that a small amount of current is being supplied to the unit to back up the memory contents. This mode is referred to as the Standby mode. While the STANDBY indicator is lit, the power of the system can be switched ON/OFF from the remote control unit.

Remote control operation (KR-896/KR-796)

Cassette tape deck operation keys

Available for the cassette tape deck connected through the SYSTEM CONTROL terminals.

When using a single cassette tape deck, use the TAPE B deck.

TUNER operation keys

PRESET CALL: Select the preset stations.

BAND: Switches the bands.

CD player keys

DISC: The DISC key can be used the disc selector key of a multi-disc player with a disc changer. For details, read the instruction manual provided with the CD player.

INPUT select key

Change the input source.

POWER key

Turn the power of components ON/OFF.

MUTE key

Press to mute the volume temporarily.

VOLUME CONTROL keys

Adjust the volume level of the unit.

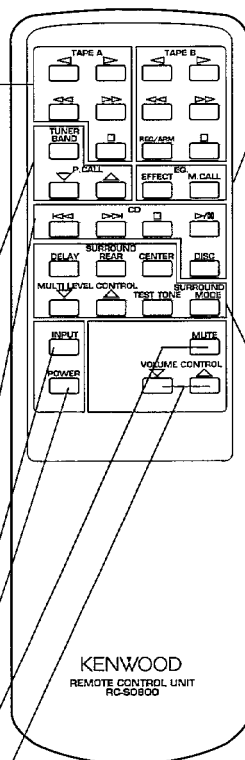

Equalizer operation keys

M. CALL: Recall the equalized patterns stored in memory.
EFFECT: Turn the graphic equalizer effect ON and OFF.

SURROUND processor operation keys
MODE: Change the surround mode among Dolby PRO LOGIC, Dolby 3 STEREO, BYPASS (OFF).

REAR: Press to adjust the rear level.
CENTER: Press to adjust the center level.
DELAY: Press to adjust the delay time.
MULTI LEVEL CONTROL: Press to adjust the level of the rear, center, delay time.
TEST TONE: Press to switch the TEST TONE ON and OFF.

Note: Change the mode among NORMAL, WIDE, PHANTOM with CENTER MODE key on the main unit.

Type: RC-S0800
System: Infrared control

■ Loading the batteries

1 Remove the cover.

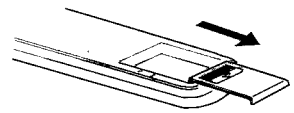

2 Insert batteries.

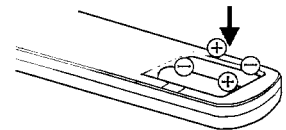

Insert two batteries (R6/AA) as indicated by the polarity marking.

3 Close the cover.

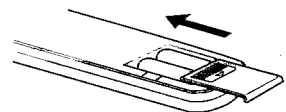

■ Operating procedure

Plug the power cord of the system into an AC wall outlet, and press the **POWER** key on the remote control unit to turn the power on.

When the power is turned on, press the key of the source component to be operated.

- When two operation key on the remote control unit are pressed successively, press each key securely reserving an interval of more than 1 second for each press.
- Components connected via the system control cords can also be remote-controlled. In this case, please read the instruction manual supplied with your component.

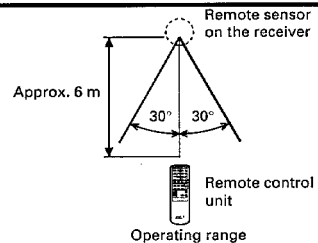

Notes:

1. The supplied batteries are intended for use in operation checks. Therefore, their lives may be shorter than ordinary batteries.
2. When the remote-controllable distance gets shorter than before, replace both batteries with new ones.
3. Malfunction may occur if direct sunlight or the light of a high-frequency lighting fluorescent lamp enters the remote control light sensor. In such a case, change the system installation position to prevent the malfunction.

Remote control operation (KR-596)

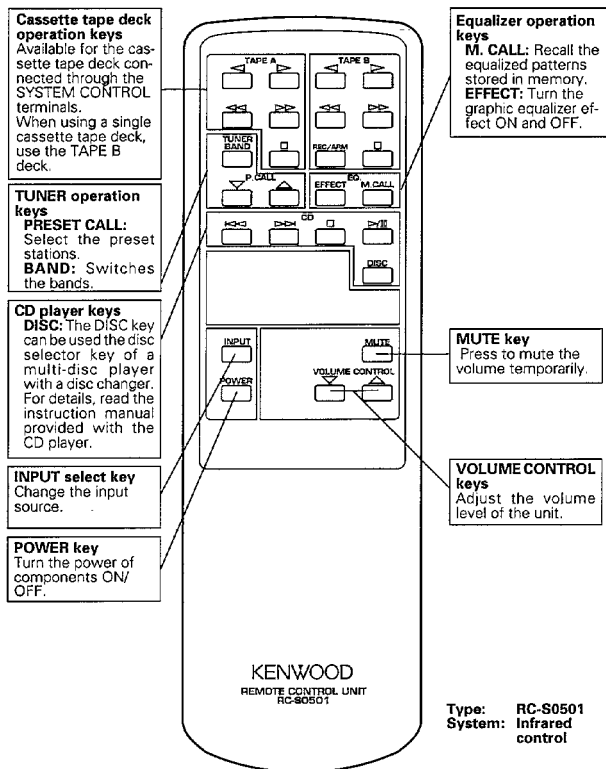

■ Loading the batteries

1 Remove the cover.

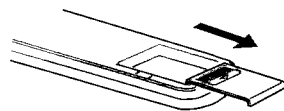

2 Insert batteries.

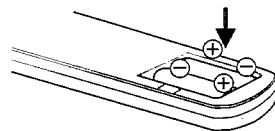

Insert two batteries (R6/AA) as indicated by the polarity marking.

3 Close the cover.

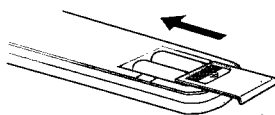

■ Operating procedure

Plug the power cord of the system into an AC wall outlet, and press the **POWER** key on the remote control unit to turn the power on.

When the power is turned on, press the key of the source component to be operated.

- When two operation key on the remote control unit are pressed successively, press each key securely reserving an interval of more than 1 second for each press.
- Components connected via the system control cords can also be remote-controlled. In this case, please read the instruction manual supplied with your component.

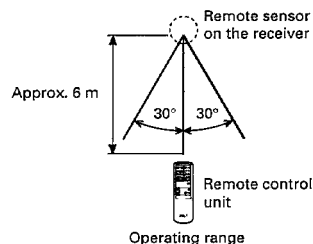

Notes:

1. The supplied batteries are intended for use in operation checks. Therefore, their lives may be shorter than ordinary batteries.
2. When the remote-controllable distance gets shorter than before, replace both batteries with new ones.
3. Malfunction may occur if direct sunlight or the light of a high-frequency lighting fluorescent lamp enters the remote control light sensor. In such a case, change the system installation position to prevent the malfunction.

Operating instructions

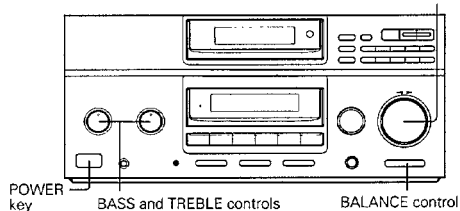
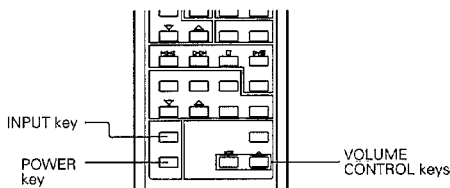

■ Basic operation

1 Turn the POWER ON.

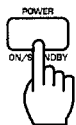

Main unit

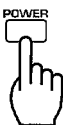

Remote control unit

2 Select the input source.

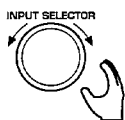

Main unit



Remote control unit

The input selector is changed as follows. Changed counterclockwise only by using the remote control unit

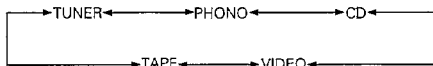

The selected source name appears on the display.

TUNER

3 Play the source component.

- The selected source component starts playing automatically if it is connected by a system control cord.

4 Adjust the volume.

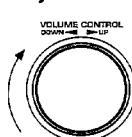

Main unit

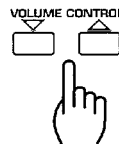

Remote control unit

Volume level is indicated with 10 point bars and level in dB.



5 Adjust the left and right volume balance.

To decrease right speaker volume

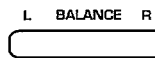

To decrease left speaker volume

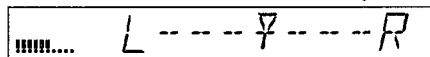

6 Adjust the tone controls.

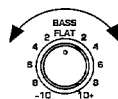

To decrease bass

To increase bass

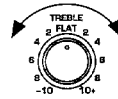

To decrease treble

To increase treble

Notes on input selector

The source last selected with the input selector is backed up for a few days even when the power cord is unplugged. After this period, the receiver is automatically selected when the power is turned on.

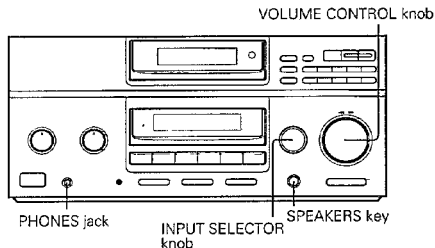
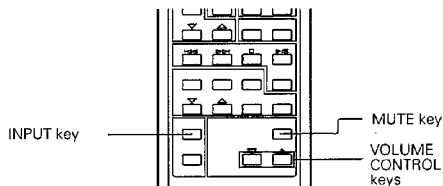

■ To mute the sound temporarily

Press the MUTE key.

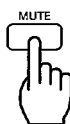

MUTING indicator blinks.



Remote control unit

- Pressing the key again resumes the previous volume.

■ Listening through headphones

1 Insert the headphones plug into the PHONES jack.

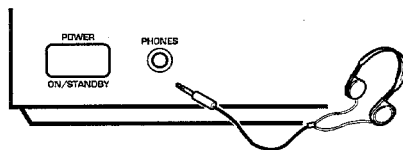

- Set the SPEAKERS switch to OFF.

2 Adjust the volume.

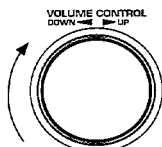

Main unit

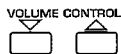

Remote control unit

■ Ordinary tape recording

1 Select the source to be recorded.

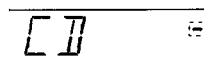

2 Set the cassette deck to the record-pause mode and start recording it on the cassette deck.



Record-pause mode

3 Play the source component to be recorded.

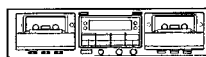

Recording starts.

Note:

The input source cannot be changed over while the cassette deck connected to this unit via the system control cord is in the record mode. When it is required to change the input source, put the cassette deck in the stop mode beforehand.

SPEAKERS key

- OFF: This position silences all speakers to permit private use of headphones (SPEAKER indicator goes off.)
- ON: Activates the speakers connected to the SPEAKERS A terminals on the rear panel. (SPEAKER indicator lights on.)



KR-596



KR-896/KR-796

Speaker indicator

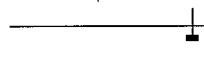

Reception of radio broadcast

■ Receiving broadcast stations and storing them in memory (preset operation)

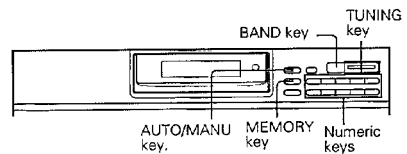

1 Select the TUNER with the INPUT SELECTOR knob.

The frequency mode

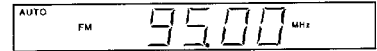

2 Select the broadcast band.

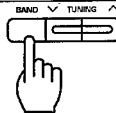

Each time the BAND key is pressed, the reception band changes.

FM ↔ AM

- If the keys related to tuner reception are pressed, the display changes to frequency mode in a few seconds.

3 Select the tuning mode.



AUTO lights up

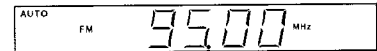

- The indicator goes on (auto) and off (manual) alternately every time the key is pressed. Normally, select the auto tuning mode.

4 Tune a desired station.

To increase the frequency

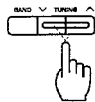

To decrease the frequency

- The TUNED indicator lights up when a station is received.
- Use manual tuning mode in case the radio wave is weak and noisy. At this time, the stereo FM broadcast is received in monaural mode.

Auto tuning mode

Just press once. (Tuning stops automatically when a station is received.)

Manual tuning mode

Press repeatedly, or press and hold, until the station is received.

5 Store the stations in preset memory.

- (1) Press the MEMORY key.

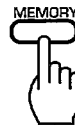

MEMORY indicator lights up for about 5 seconds

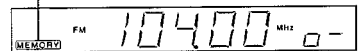

- Proceed the step 2 while the MEMORY indicator is lighted.
- (2) Press the numeric keys to preset the station.

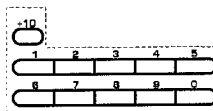

MEMORY goes off

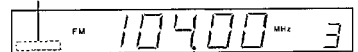

Examples

- To select preset No. 03...[3]
- To select preset No. 10...[10], [0]
- To select preset No. 20...[20], [10], [0]

- If a station has been preset under the numeric key pressed, the previous preset content is replaced by the new station.
- Repeat step 2 to 5 above for each of other stations to be preset.
- A total of 30 stations can be preset in memory regardless of their broadcast bands.

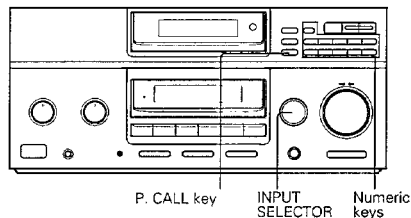
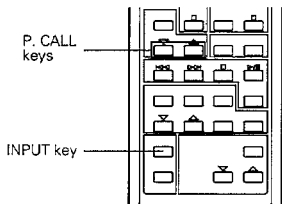

■ Receiving a preset station

1 Set to Tuner.

Select with the input selector knob.

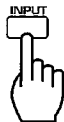
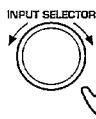

2 Selected the desired station.

Press the numeric key under which the station is preset.

Example

When receiving preset 29, ... \square \square \square \square \square \square \square \square \square \square

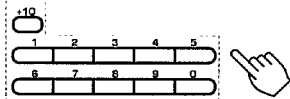

- The frequency of the station received will be displayed.

■ Listening to all preset stations in sequence (P.CALL)

Press the P.CALL key.

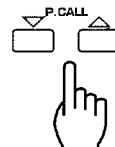

Preset stations are received in order of 1,2,3,...30 every time the key on the main unit is pressed.

With the key on the remote control unit, preset stations are received in order of 1,2,... every time the Δ key is pressed, or in order of 30,29,... every time the ∇ key is pressed.

Holding one of these keys pressed recalls the preset stations in sequence at 0.5-second intervals. When the key is release, the current preset station is received.

■ Playback of videotape

1 Select the VIDEO input with the input selector.

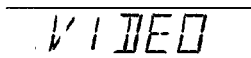

2 Play the VCR.

3 Adjust the volume.

Last channel memory

When the band is switched or when the input selector is switched from another source to TUNER, the last received station is recalled.

Operation of Dolby surround playback (KR-896/KR-796 only)

Surround effect

The powerful feeling of enveloping sound experienced in places such as movie theaters is due to the fact that sound comes from not only in front but also from the periphery. To reproduce this type of feeling, this unit incorporates surround decoder. To extract the maximum surround effect, read this instruction manual thoroughly and adjust the system to match the configuration of your listening room.

Presence

Dolby PRO LOGIC surround

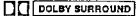
Videotapes and laserdiscs which bear the  mark are recorded with the same Dolby surround data used in movie theaters. Since this unit incorporates a Dolby PRO LOGIC surround decoder, you can enjoy the same acoustic effects experienced in movie theaters in the comfort of your own home.

Dolby 3 STEREO

With widely spaced left and right speakers, the center channel image for off-axis listeners shifts according to seating position. Dolby 3 Stereo localizes the center image regardless of seating position, improving the image over that with conventional stereo.

■ Speaker positioning

Standard layout

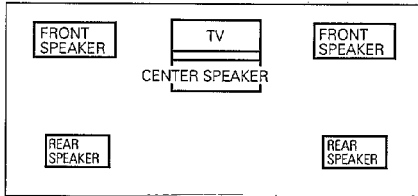

Dolby PRO LOGIC mode

Set the center mode according to the size of the center speaker:

- NORMAL** : When the center speaker size is small.
- WIDE BAND** : When the center speaker size is large or medium.

When no rear (surround) speakers are used

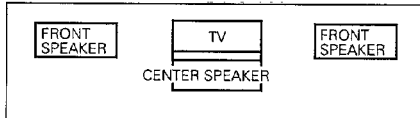

Dolby 3 STEREO mode

Set the center mode according to the center speaker size.

- NORMAL** : When using a small center speaker.
- WIDE BAND** : When using a medium-sized or larger center speaker.

When no center speaker is used

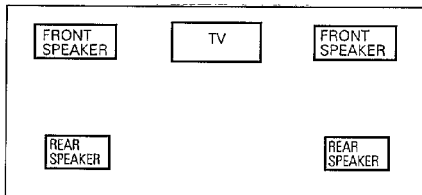

Dolby PRO LOGIC mode

Set the center mode to PHANTOM.

Manufactured under license from Dolby Laboratories Licensing Corporation. Additionally licensed under one or more of the following patents: U.S. numbers 3,959,590; Canadian numbers 1,004,603 and 1,037,877. "Dolby", "Pro logic" and the double-D symbol  are trademarks of Dolby Laboratories Licensing Corporation.

Operation of Dolby PRO LOGIC playback (KR-896/KR-796 only)

■ Dolby PRO LOGIC field adjustment

1 Set the Dolby PRO LOGIC mode.

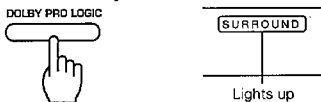

2 Select the center mode.

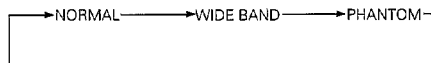

Click on the CENTER MODE key with a pointed object such as a ballpoint pen.

Every time the key is pressed, the center mode is switched.

- Refer to column "Center mode" below.

3 Adjust the volume balance.

① Press the TEST TONE key.

A buzzing sound comes from the speaker. It is switched every one and half second for each one.



Remote control unit only

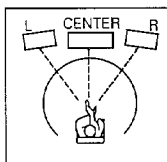

- Press at the listening position.

In NORMAL or WIDE BAND mode:

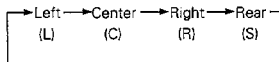

In PHANTOM mode:

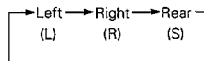

② Adjust the volume balance.

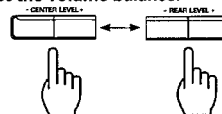

- Adjust so that the test tone volumes are the same on all speakers.
- The level being adjusted is displayed.
- The center level cannot be adjusted in the PHANTOM mode.

4 Stop generating the test tone.



Remote control unit only

5 Set the delay time.

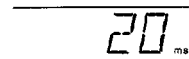

- Calculate the proper delay time for Dolby Surround by referring to the illustration below.
- The delay time can be adjusted in the range from 15 to 30 ms.
- When the DELAY TIME key is pressed a delay time appears on the display. It varies every time the key is pressed.
15 ms ↔ 20 ms ↔ 25 ms ↔ 30 ms
- Once a delay time is set, it is automatically held in memory so the same delay time is displayed whenever Dolby Surround is switched ON later.

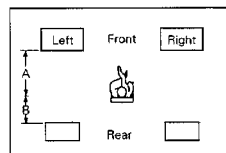

Delay time (ms) = 15 ms + 5 ms (A - B)

A: Distance of front speaker (m)

B: Distance of rear speaker (m)

Center mode

Select one of the following center modes according to the type of the presence speakers in you system.

NORMAL : Use this mode with a center speaker of a compact size.

WIDE BAND : Use this mode with a center speaker of a medium or larger size.

- If you cannot identify whether your center speaker is of the medium or compact size, try both the NORMAL and WIDE BAND mode and use the one that can provide better sound positioning.

PHANTOM : Use this mode when the center speaker is not used.

- Even without the center speaker, the signal is processed in a simulated manner to ensure proper center image positioning and provide the enjoyment of Dolby Surround.



Click on the CENTER MODE key with a pointed object such as a ballpoint pen.

Every time the key is pressed, the center mode is switched.

■ Operation of Dolby PRO LOGIC playback

This function allows to enjoy a similar Dolby Surround effect to movie theaters from video software programs carrying the  **DOLBY SURROUND** mark.

Before using the Dolby PRO LOGIC mode, be sure to perform the "Dolby PRO LOGIC field adjustment" procedure.

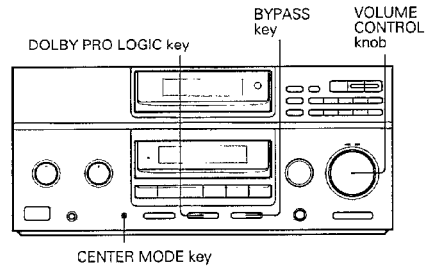

1 Set the Dolby PRO LOGIC mode.



Lights up



2 Select the center mode.



Click on the CENTER MODE key with a pointed object such as a ballpoint pen.

Every time the key is pressed, the center mode is switched.

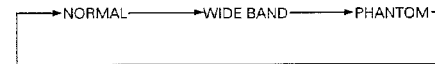
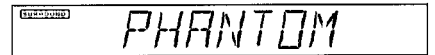

- Select the mode which has been set in step 3 of the "Dolby PRO LOGIC field adjustment" procedure. (Refer to page 15.)

3 Play a software program encoded with Dolby Surround.

4 Adjust the volume and tone.

- When the level balance of center and rear speakers is not good, perform the "Dolby PRO LOGIC field adjustment" procedure again.

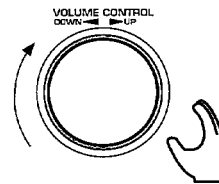

To return to normal stereo playback.

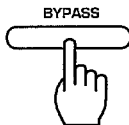

SURROUND
goes off.

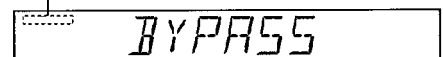

Dolby 3 STEREO mode (KR-896/KR-796 only)

The Dolby 3 STEREO provides a active center channel to produce a better, stable center image. This mode can be used when listening to stereo video program and music or when surround listening or surround system set-up is not possible.

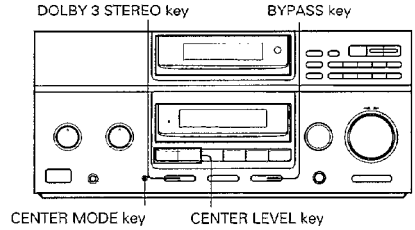
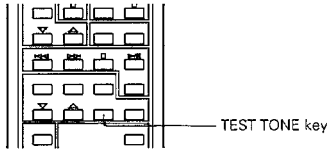

■ Dolby 3 STEREO adjustment

1 Set the Dolby 3 STEREO mode.

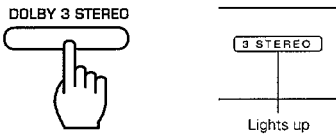

2 Select the center mode.

Every time the key is pressed, the center mode is switched.

NORMAL ↔ WIDE BAND

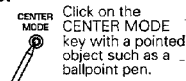

- Set the center mode to NORMAL if using a small center speaker, or set to WIDE BAND if using a medium-sized or larger speaker.

3 Adjust the center speaker volume.

① Press the TEST TONE key.

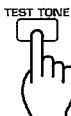

A buzzing sound comes from the speaker. It is switched every one and half second for each other.

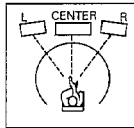

Remote control unit only

- Press at the listening position.
- When at 3 Stereo, sound is produced in sequence: LEFT → CENTER → RIGHT (REAR is not available with 3 stereo mode.)

② Adjust the volume.

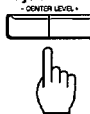

- Adjust so that the level of the center speaker is equal to that of the left and right speakers.
- The rear level adjustment is invalid.

4 Stop generating the test tone.

Press the key again.

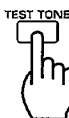

■ Dolby 3 STEREO playback

1 Set the Dolby 3 STEREO mode.

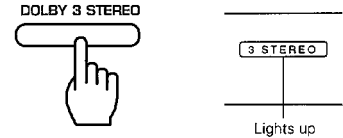

2 Select the center mode.

Every time the key is pressed, the center mode is switched.

NORMAL ↔ WIDE BAND

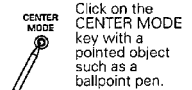

- Set the center mode to NORMAL if using a small center speaker, or set to WIDE BAND if using a medium-sized or larger speaker.

3 Play a stereo software or a Dolby surround program.

4 Adjust the volume and tone.

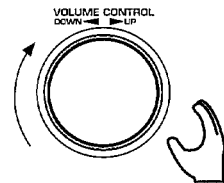

To return to normal stereo playback

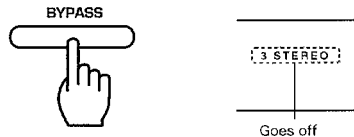

In case of difficulty

What appears to be a malfunction may not always be serious. If your unit should not perform as expected, consult the table below to see if the problem can be corrected before seeking help from your dealer or service representative.

To reset the microprocessor

The microprocessor may malfunction (impossibility of any operation, erroneous display, etc.) when a connection cord is unplugged or plugged while the power is ON or due to other external causes. In this case, try the method described below to reset the microprocessor and return to normal operation.

Unplug power cord from outlet and plug it back in while holding down the POWER key.

Remote control unit

Symptom	Cause	Remedy
Remote control unit operation is not possible.	<ul style="list-style-type: none"> Batteries are exhausted. The audio cords and the system control cords are not connected properly. The source component to be operated does not contain the analog disc, tape (s) or CD. An attempt is made to play a tape which is being recorded in the cassette deck. 	<ul style="list-style-type: none"> Replace with new batteries. Connect properly referring to "System connections". Place a record, tape(s) or CD in the source component to be played. Wait until the recording is completed.

Tuner section

Symptom	Cause	Remedy
Radio stations cannot be received.	<ul style="list-style-type: none"> No antenna is connected. 	<ul style="list-style-type: none"> Connect an antenna.
A station which was preset cannot be received by pressing the corresponding numeric key.	<ul style="list-style-type: none"> The preset station belongs to a frequency that cannot be received. The preset memory was cleared because the power cord was unplugged for a long period of time. 	<ul style="list-style-type: none"> Preset a station with a receivable frequency. Preset the station again.
Interference	<ul style="list-style-type: none"> Noise due to ignition noise of automobiles. Noise due to an influence from an electric appliance. Noise due to a nearby TV set. 	<ul style="list-style-type: none"> Install the outdoor antenna away from the road. Turn off the power of the appliance. Install the system further away from the TV set.

Amplifier section, speakers

Symptom	Cause	Remedy
Sound is not output.	<ul style="list-style-type: none"> The speaker cords are disconnected. The VOLUME CONTROL is set to minimum position. The MUTE key is set to ON. 	<ul style="list-style-type: none"> Connect properly referring to "System connections". Adjust the volume to a proper level. Press the MUTE key to OFF.
Sound is not output from one of the speakers.	<ul style="list-style-type: none"> The speaker cord is disconnected. The BALANCE control is set to an extreme position. 	<ul style="list-style-type: none"> Connect properly referring to "System connections". Adjust the Left/Right balance.
Sound is not output from the Surround rear speaker, or Center speaker or sound is very small.	<ul style="list-style-type: none"> The rear speaker cords are disconnected. The surround play mode has not been engaged. The CENTER/REAR LEVEL are set to the minimum level. 	<ul style="list-style-type: none"> Connect properly referring to "System connections". Set the Dolby Surround. Adjust the CENTER/REAR LEVEL controls.
A hum noise is generated when the PHONO input selector is selected.	<ul style="list-style-type: none"> The audio cord from the turntable is not inserted securely into the PHONO jacks. The turntable is not grounded. 	<ul style="list-style-type: none"> Insert the audio cord plugs securely into the PHONO jacks. Connect the grounding wire to the GND terminal on the rear panel.

Note:

Do not use contact cleaners because it could cause a malfunction. Be specially careful against contact cleaners containing oil, for they may deform the plastic components.

Specifications

 **Caution: Read this page carefully to ensure safe operation.**

U.S.A. and Canada

AUDIO section

Rated power output at the STEREO operation
(KR-896/KR-796/KR-596)

100 watts per channel minimum RMS, both channels driven, at 8Ω from 40 Hz to 20,000 Hz with no more than 0.09% total harmonic distortion. (FTC)

Power output at the Surround operation
(KR-896/KR-796 only)

Front (1 kHz, 0.9% T.H.D. at 8 Ω) 70 W + 70 W
Center (1 kHz, 0.9% T.H.D. at 8 Ω) 30W
Rear (1 kHz, 0.9% T.H.D. at 8 Ω) 15 W + 15 W

Total harmonic distortion (1 kHz, 8 Ω) 0.05% at 50W
Signal to noise ratio (IHF'66)

PHONO (MM) 70 dB
CD, TAPE, VIDEO 95 dB

Input sensitivity/impedance

PHONO (MM) 3.5 mV/47 kΩ
CD, TAPE, VIDEO 200 mV/47 kΩ

Tone controls

BASS ± 10 dB (at 100 Hz)
TREBLE ± 10 dB (at 10 kHz)

FM tuner section

Tuning frequency range 87.5 MHz ~ 108 MHz
Usable sensitivity (IHF) 13.2 dBf (1.2 μV at 75 Ω)
50 dB quieting sensitivity

STEREO 41.2 dBf (3.2 μV at 75 Ω)
Total harmonic distortion at 1 kHz

MONO 0.6%
STEREO 0.7%

Signal to noise ratio at 65 dBf (IHF)

MONO 75 dB
STEREO 68 dB

Selectivity (IHF ± 400 kHz) 50 dB

Stereo separation (IHF at 1 kHz) 40 dB

Frequency response 30 Hz ~ 15 kHz, +0.5 dB, -3.0 dB

AM tuner section

Tuning frequency range 530 kHz ~ 1,700 kHz

Usable sensitivity 12 μV/(500 μV/m)

Total harmonic distortion 0.7%

Signal to noise ratio 48 dB

Selectivity 30 dB

General

Power consumption

..... 2.5 A (KR-896/KR-796) 2.3 A (KR-596)

AC outlet

SWITCHED 2: (Total 200 W 1.6 A max.)

Dimensions W: 440 mm (17-5/16")

H: 192 mm (7-9/16")

D: 300 mm (11-13/16")

Weight (Net) 10.5 kg (23.1 lb)

Other countries (KR-896)

AUDIO section

Rated power output at the STEREO operation

(EIAJ) from 40 Hz to 20 kHz,
0.09% T.H.D. at 8 Ω 100 W + 100 W
(EIAJ) 1 kHz, 10% T.H.D. at 8 Ω 130 W + 130 W

Power output at the Surround operation

Front (1 kHz, 0.9% T.H.D. at 8 Ω) 70 W + 70 W
Center (1 kHz, 0.9% T.H.D. at 8 Ω) 30 W
Rear (1 kHz, 0.9% T.H.D. at 8 Ω) 15 W + 15 W

Total harmonic distortion (1 kHz, 8 Ω) 0.05% at 50W
Signal to noise ratio (IHF'66)

PHONO (MM) 70 dB
CD, TAPE, VIDEO 95 dB

Input sensitivity/impedance

PHONO (MM) 3.5 mV/47 kΩ
CD, TAPE, VIDEO 200 mV/47 kΩ

Tone controls

BASS ± 10 dB (at 100 Hz)
TREBLE ± 10 dB (at 10 kHz)

FM tuner section

Tuning frequency range 87.5 MHz ~ 108 MHz

Usable sensitivity (IHF) 13.2 dBf (1.2 μV at 75 Ω)

50 dB quieting sensitivity

STEREO 41.2 dBf (3.2 μV at 75 Ω)

Total harmonic distortion at 1 kHz

MONO 0.6%
STEREO 0.7%

Signal to noise ratio at 65 dBf (IHF)

MONO 75 dB
STEREO 68 dB

Selectivity (IHF ± 400 kHz) 50 dB

Stereo separation (IHF at 1 kHz) 40 dB

Frequency response 30 Hz ~ 15 kHz, +0.5 dB, -3.0 dB

AM tuner section

Tuning frequency range

9 kHz 531 kHz ~ 1,602 kHz

10 kHz 530 kHz ~ 1,610 kHz

Usable sensitivity 12 μV (500 μV/m)

Total harmonic distortion 0.7%

Signal to noise ratio 48 dB

Selectivity 30 dB

General

Power consumption

..... 230 W

AC outlet

SWITCHED 2: (Total 200 W max.)

Dimensions W: 440 mm

H: 192 mm

D: 300 mm

Weight (Net) 10.5 kg

Note:

KENWOOD follows a policy of continuous advancements in development. For this reason specifications may be changed without notice.

For the U. S. A.

Note to CATV system installer:

This reminder is provided to call the CATV system installer's attention to Article 820-40 of the NEC that provides guidelines for proper grounding and, in particular, specifies that the cable ground shall be connected to the grounding system of the building, as close to the point of the cable entry as practical.

For the U. S. A.

FCC WARNING:

This equipment may generate or use radio frequency energy. Changes or modifications to this equipment may cause harmful interference unless the modifications are expressly approved in the instruction manual. The user could lose the authority to operate this equipment if an unauthorized change or modification is made.

NOTE:

This equipment has been tested and found to comply with the limits for a Class B digital device, pursuant to Part 15 of the FCC Rules. These limits are designed to provide reasonable protection against harmful interference in a residential installation. This equipment may cause harmful interference to radio communications, if it is not installed and used in accordance with the instructions. However, there is no guarantee that interference will not occur in a particular installation. If this equipment does cause harmful interference to radio or television reception, which can be determined by tuning the equipment off and on, the user is encouraged to try to correct the interference by one or more of the following measures:

- Reorient or relocate the receiving antenna.
- Increase the separation between the equipment and receiver.
- Connect the equipment into an outlet on a circuit different from that to which the receiver is connected.
- Consult the dealer or an experienced radio/TV technician for help.